

Augmented vocational tools using real time audio-visual feedback for psychomotor skill training

Nagarajan Akshay[#], Sasi Deepu[#], Rao R. Bhavani[#]

[#]AMMACHI Labs, Amrita Vishwa Vidyapeetham
Amritapuri, Kerala, India

{akshayn,deepuds,bhavani}@am.amrita.edu

Abstract— This paper presents the concept design of SMART (Skill Mentoring and Assistance in Real Time), a novel motion monitoring and audio-visual feedback device for the students in Vocational Education and Training (VET) to assist in minimizing and in correcting the errors in the use of occupational tools. SMART is easily attached to any vocational tool and can guide the user to conform to specific spatiotemporal trajectories and orientation as described by template shape. The paper provides a description of the low cost accelerometer, gyroscopes and an input interface that are integrated with the micro controller and proposes an algorithm to provide such guidance for the tool.

Keywords— Inertial measurement unit, vocational education, skill development, accelerometer, gyroscope, motion tracking, psychomotor training.

I. INTRODUCTION

India has 456 million people living below the poverty line as per the World Bank estimates [1]. It is understood that the only hope to have a better social well being for these people is to raise their economic productivity [2]. Vocational education and training (VET) institutes provide a way through which a skilled workforce can be built for greater economic growth. Nearly 12 million youth are added to the Indian workforce every year. But as of 2007 Government of India census, the number of vocational institutes in India are 5000 ITIs and 7,000 secondary vocational schools, compared poorly with the 500,000 secondary vocational schools in the Peoples Republic of China [3].

Assistive technologies have for long played an important role in medical rehabilitation [4][5], posture correction [6] and motor motion monitoring [7]. Such technologies if employed to VET can play a very significant role to fill the gap in developing nations such as India, by preparing a new breed of technicians and skilled labor that can learn faster and perform better. These solutions need to be simple, scalable, cost effective, a retrofit and at the same time augment the learning of a student significantly. A retrofit solution is one that can modernize the existing equipment without the need to have to invest in completely replacing the old. A scalable solution is something that can support much equipment and can be mass-produced without the need to greatly customize it. The solution needs to be simple enough to use and learn with minimal guidance from the trainers. Above all, the solution

needs to be cost effective in mass deploying across all old and new VET institutes.

The SMART device that is proposed in this paper is scalable, simple and cost effective and a retrofit. It can help train a novice the use of a vocational tool effectively by providing constant audio and visual feedback in real time or act as assistance for a practicing professional. The real-time feedback audio and visual cues help correct orientation and direction of motion of the tool on which SMART is attached and boost psychomotor skill. SMART can provide a solution to problem of shortage of skilled instructors, who are well informed of recommended practices in VET centers, which adversely affects the quality of skill of the trainees. SMART aims to reduce the dependency on trainers and let the student learn to work with tools at their own pace.

SMART contains an inertial measurement unit (IMU), a simple input interface to select the type of tool it is attached on using a inelastic Velcro strap and the template shape along which the tool is going to be operated. Inertial Measurement units (IMUs) are capable of monitoring human body motions using the dead reckoning measurement technique [8].

II. SYSTEM DESIGN

SMART consists of a triple axis accelerometer and three single axis gyroscopes, which actively provides the displacement and tilt of the tool on which it is attached. SMART can be used in multiple capacities for various tasks and to be attached on different kinds of vocational tools to teach several categories of skills, namely, correct orientation, straightness and cutting specific patterns by following a given curved trajectory.

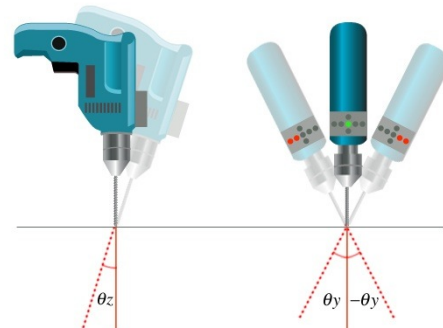

Fig. 1. Orientation measurement and visual indication provided by SMART on an electric drill.

For the tools that require the user to maintain correct orientation, such as the electric hand drill, the SMART device helps teach the correct holding position while drilling a hole in a material. The gyroscope in the SMART device provides the necessary tilt information to control the orientation of the tool. The visual indicator mounted on the electric drill indicates the orientation is correct by glowing green when the electric drill is vertical to the surface of the material drilled on, as illustrated in Fig. 1. The indicator lights glow red progressively in accordance to the tilt in any axis and an audio feedback directs the user to correct the holding orientation.

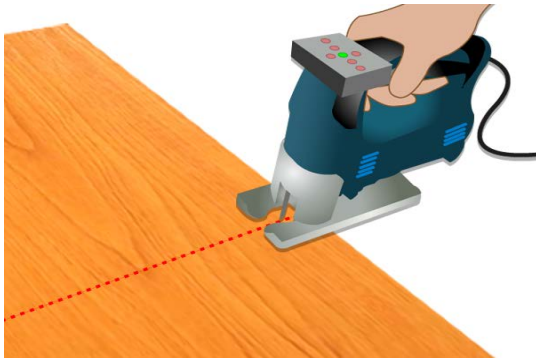

Fig. 2. SMART attached on the Jigsaw handle that is to be cut along the template marked red line.

In case of tools where displacement and orientation are of pertinence, such as in the jigsaw, router or circular saw, SMART provides the user with guidance to cut along the marked template line. As shown in Fig. 2, the user is guided to cut along the drawn straight red line using the jigsaw. This is accomplished with the use of the accelerometer to measure displacement and the gyroscopes to detect tilt if any, which then triggers the visual and audio feedback mechanisms.

A. The Inertial Measurement Unit

SMART consists of a 6 degree of freedom inertial measurement unit, consisting of one triple-axis accelerometer and three single axis gyroscopes. The IMU is assembled from low cost MEMS components in a strap-down configuration [9], such that the accelerometer and gyroscopes are integrated on a common chassis instead of being controlled on gimbals. With a physical dimension of 47 x 37 x 25 mm this unit is convenient to attach on to the tool.

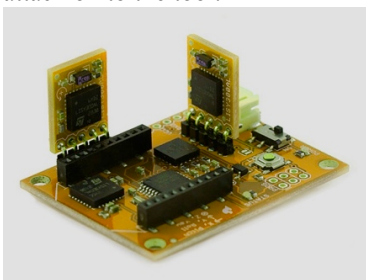

Fig. 3. The PCB of the SMART Inertial Measurement Unit consisting of one accelerometer and three gyroscopes.

The Freescale Semiconductors MMA7361L is a 3-axis accelerometer, which is configurable to a sensitivity of up to

6g. It is sufficient for tracking the position of the moving tool owing to its high sensitivity (800 mV/g @ 1.5g) and data sampling rate of 400Hz for x and y axes and 300Hz for z axis, given that typically acceleration for hands and arms ranges from 0.5g to 0.9g with a frequency of less than 12Hz [10].

The LISY300AL from STMicroelectronics is a single-axis analog output yaw rate gyroscope with a resolution of $\pm 300^\circ/s$ and sensitivity of up to 3.3mV/°/s. The gyroscope provides yaw rate angular velocity that is integrated to obtain the angle of orientation [11]. Three gyroscopes of the same kind, sampled at a data rate of 88Hz detect the angular movements in the three Euler's axes.

B. The User Interface

SMART is equipped with an alpha numeric LCD display unit and three push button switches for scrolling and selecting different tools and templates from a menu.

Real-time feedback to the user is provided by an LED array of red LEDs surrounding a green LED as seen mounted on the jigsaw in Fig. 2. Additionally, an ISD 1900 voice recorder IC preprogrammed with voice instructions of up to 32 seconds length each, provides the user with a more intuitive guidance mechanism to correct their orientation and position.

C. Control System

The IMU unit is run as a hard-wired UART interface achieving baud rate speeds of up to 115200bps.

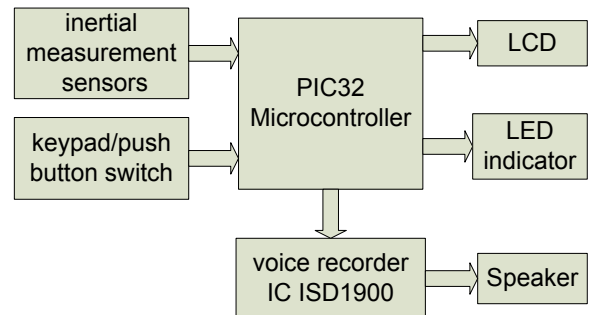

Fig. 4. Block Diagram showing the System Architecture of SMART

A PIC MIPS 32-bit high performance RISC microcontroller, sampling at a speed of 10 MHz with six dedicated 10-bit ADC channels reads the data from the sensors through the UART. It additionally supports the menu selection using push buttons and audio-visual feedback as shown in Fig. 4.

D. Algorithm

An algorithm was developed to detect the user deviating from the marked line when using a tool such as the jigsaw (see Fig. 1) and to provide real-time feedback consistent with the extent of deviation.

The user has to first select from a menu list the tool on which SMART is attached and the template of the trajectory selected to operate along. Once the tool is placed on the starting location on the work piece, a third button should be pressed. This calibrates the SMART sensors to the initial conditions. Then the operation can begin.

While in operation, the deviation from the marked line can occur such that it gives rise to four cases.

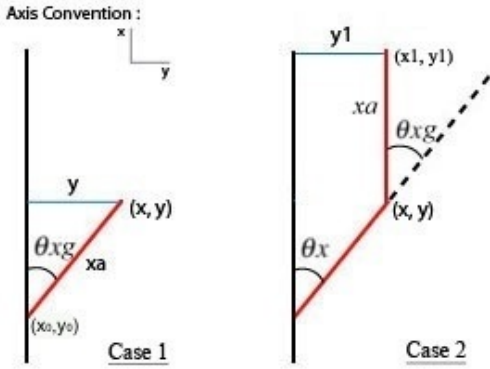

Fig. 5. Trajectories in red of the tool movement showing deviation from desired black line.

Case 1: First deviation from (x_0, y_0) : As shown in Fig. 5, the dark black line denotes the template line trajectory along which the user is to use the tool. If the user deviates arbitrarily from the line, causing an erroneous movement, the calculated displacement in the y-axis will trigger the feedback signals.

The instantaneous position of the tool (x, y) from the initial position (x_0, y_0) can be calculated by the expression:

$$x = x_0 + x_a \cdot \cos(\theta_{xg})$$

$$y = y_0 + x_a \cdot \sin(\theta_{xg})$$

respectively, where θ_{xg} denotes the tilt angle of deviation as measured by the gyroscope and x_a is the distance travelled calculated from the accelerometer readings attached to the tool.

Case 2: Second deviation ($|\theta_{xg}| = -\theta_x$): In case of any subsequent deviation from the initial deviated trajectory, shown in Fig. 5, the instantaneous position of the tool (x_1, y_1) is given by:

$$x_1 = x + x_a \cdot \cos(\theta_{xg} + \theta_x) \quad \dots\dots(1)$$

$$y_1 = y + x_a \cdot \sin(\theta_{xg} + \theta_x) \quad \dots\dots(2)$$

Since $\theta_{xg} = -\theta_x$, we have in 1 and 2,

$$x_1 = x + x_a \text{ and}$$

$$y_1 = y$$

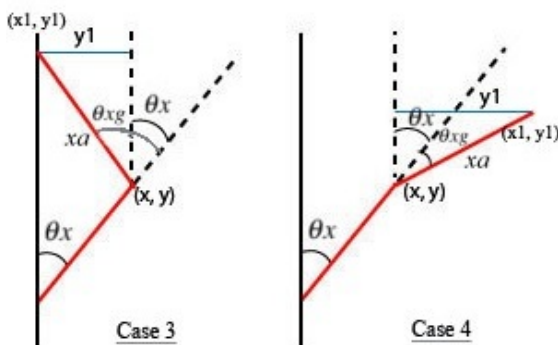

Fig. 6. Trajectories in red of the tool movement showing deviation from desired black line.

Case 3: Second deviation inwards ($\theta_{xg} < \theta_x$)

When the tool tilts to draw an acute angle with the desired trajectory, the gyroscope provides a negative value for the angle i.e θ_{xg} will be a negative value.

So from Fig. 6, the instantaneous positions can be described as:

if only either θ_{xg} or θ_x is negative

$$x_1 = x + x_a \cdot \cos(-\theta_{xg} + \theta_x) \quad \dots\dots(3)$$

$$y_1 = y - x_a \cdot \sin(-\theta_{xg} + \theta_x) \quad \dots\dots(4)$$

or if both θ_{xg} and θ_x are of the same polarity

$$x_1 = x + x_a \cdot \cos(-\theta_{xg} + \theta_x) \quad \dots\dots(5)$$

$$y_1 = y + x_a \cdot \sin(-\theta_{xg} + \theta_x) \quad \dots\dots(6)$$

Case 4: Second deviation outwards ($\theta_{xg} > \theta_x$)

When the tool deviates from the previous trajectory such that, the new tilt angle is obtuse to the desired trajectory (black line), as shown in Fig.6, the instantaneous position can be expressed by the equations 3, 4, 5 and 6 given above.

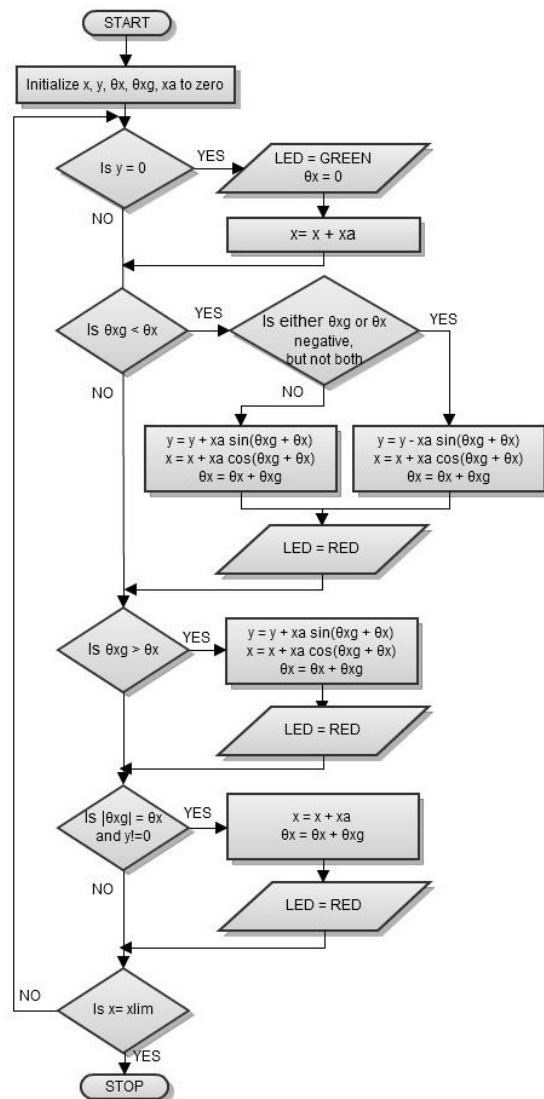

Fig. 7. The flowchart describes the position tracking and indication feedback for SMART.

The flowchart in Fig.7 represents the conditions for feedback generation during operation once the tool is in movement. Audio cues are an auxiliary addition and can be turned off for users who find it obtrusive.

III. PERFORMANCE EVALUATION

A preliminary study of the SMART device can be conducted with two groups to evaluate for various parameters such as:

- Improvement in orientation judgment
- Average decrease in deviation from given trajectory
- Reduction in time taken to learn the tool
- Scalability of learnt skill for the same tool over different materials

A first prototype of SMART was made with the visual and audio indicators placed as a separate unit, as shown in Fig. 8. This was to test usability of the user interface and to study if the users found the visual cues and auditory cues intuitive and unobtrusive, while they worked with the tool.

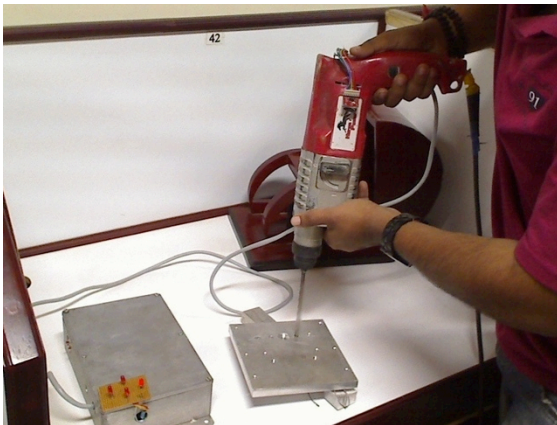

Fig. 8. A user performing drilling using an electric drill mounted with the sensors of the prototype SMART device.

We found that it was more useful to have the indicators on the tool, such that they are within the same frame of vision as when the user is looking at the work piece she or he is working on. A separate unit urged the user to look away from the work piece which is not a recommended practise and which yielded unsatisfactory results on performance.

IV. CONCLUSION AND FUTURE WORK

The design and algorithm for SMART is presented here. SMART has the potential to promote the effectiveness of learning and address the need for skilled manpower. Its simple and low cost design renders it to become a scalable solution in the field of vocational training.

The capabilities of SMART can be improved to include:

- Modularized SMART such that it can be connected to a wireless solution and run using mobile platform apps.
- More scalable technological solutions in the area of software development to include a variety of tools and material types.

- Include a magnetometer to provide more accurate directional information that may be required for certain tools which demand precision in skill.

ACKNOWLEDGMENTS

This work has been funded by the National Mission on Education through ICT, Ministry of Human Resource Development of the Govt. of India.

We wish to extend our sincere gratitude to Mata Amritanandamayi Devi, Chancellor, Amrita Vishwa Vidyapeetham for being an everlasting source of inspiration for our efforts. We also thank Joshua Freeman, Amrita Vishwa Vidyapeetham who provided his inputs during the initial phases of the concept development. We wholeheartedly thank our team at AMMACHI labs for all their support in small ways and big.

REFERENCES

- [1] A. Bauer, R. Hasan, R. Magsombol, G. Wan, "The World Bank's New Poverty Data: Implications for the Asian Development Bank", 2008 ADB Sustainable Development Working Paper Series, pp.8-9, Nov.2008, vol.2.
- [2] International Labor Organization, "Employment challenges and strategies in India," 2006.
- [3] S. Majumdar, "Workforce Development in India: policies and practice." Asian Development Bank Institute, Tech. Rep. 2008.
- [4] J.W. Burke, M.D.J. McNeill, D.K. Charles, P.J. Morrow, Crosbie, J.H.; McDonough, S.M., "Serious Games for Upper Limb Rehabilitation Following Stroke," *Games and Virtual Worlds for Serious Applications, 2009. VS-GAMES '09*, pp.103-110, March 2009.
- [5] A. Tapus, E. Wade and M. Matarie, "Using a Socially Assistive Robot in Gait Recovery and Training for Individuals with Cognitive Impairments", *AAAI 2008 Fall Symposium*, pg.128, AAAI Press. 2008.
- [6] H.J. Luinge, P.H. Veltink, "Inclination measurement of human movement using a 3-D accelerometer with autocalibration," *IEEE Transactions on Neural Systems and Rehabilitation Engineering*, vol.12, no.1, pp.112-121, March 2004.
- [7] R.A. Hyde, L.P. Ketteringham, S.A. Neild, R.J.S Jones, "Estimation of Upper-Limb Orientation Based on Accelerometer and Gyroscope Measurements," *IEEE Transactions in Biomedical Engineering*, vol.55, no.2, pp.746-754, Feb. 2008.
- [8] A.R. Jimenez, F. Seco, C. Prieto, J. Guevara, "A comparison of Pedestrian Dead-Reckoning algorithms using a low-cost MEMS IMU," *WISP 2009. IEEE International Symposium on Intelligent Signal Processing*, pp.37-42, 26-28 Aug. 2009.
- [9] P. Zhang, J. Gu, E.E. Milios, and P. Huynh, "Navigation with IMU, GPS, digital compass with unscented Kalman filter," *IEEE International Conference Mechatronics and Automation, 2005*, vol. 3, no. July, pp. 1497-1502, 2005.
- [10] G. K. H. Pang and D. C. C. Lam, "A new PCB-based low-cost accelerometer for human motion sensing," *IEEE International Conference on Automation and Logistics*, no. September, pp. 56-60, Sep. 2008.
- [11] T. Kanessalingam, "Motion Tracking Glove for Human-Machine Interaction: Inertial Guidance", M. Eng. thesis, McMaster University, Ontario, Canada, April 2010.